

NEW CLASSIC
Home Furnishings, Inc.

Oak Bunk Bed Assembly Instructions

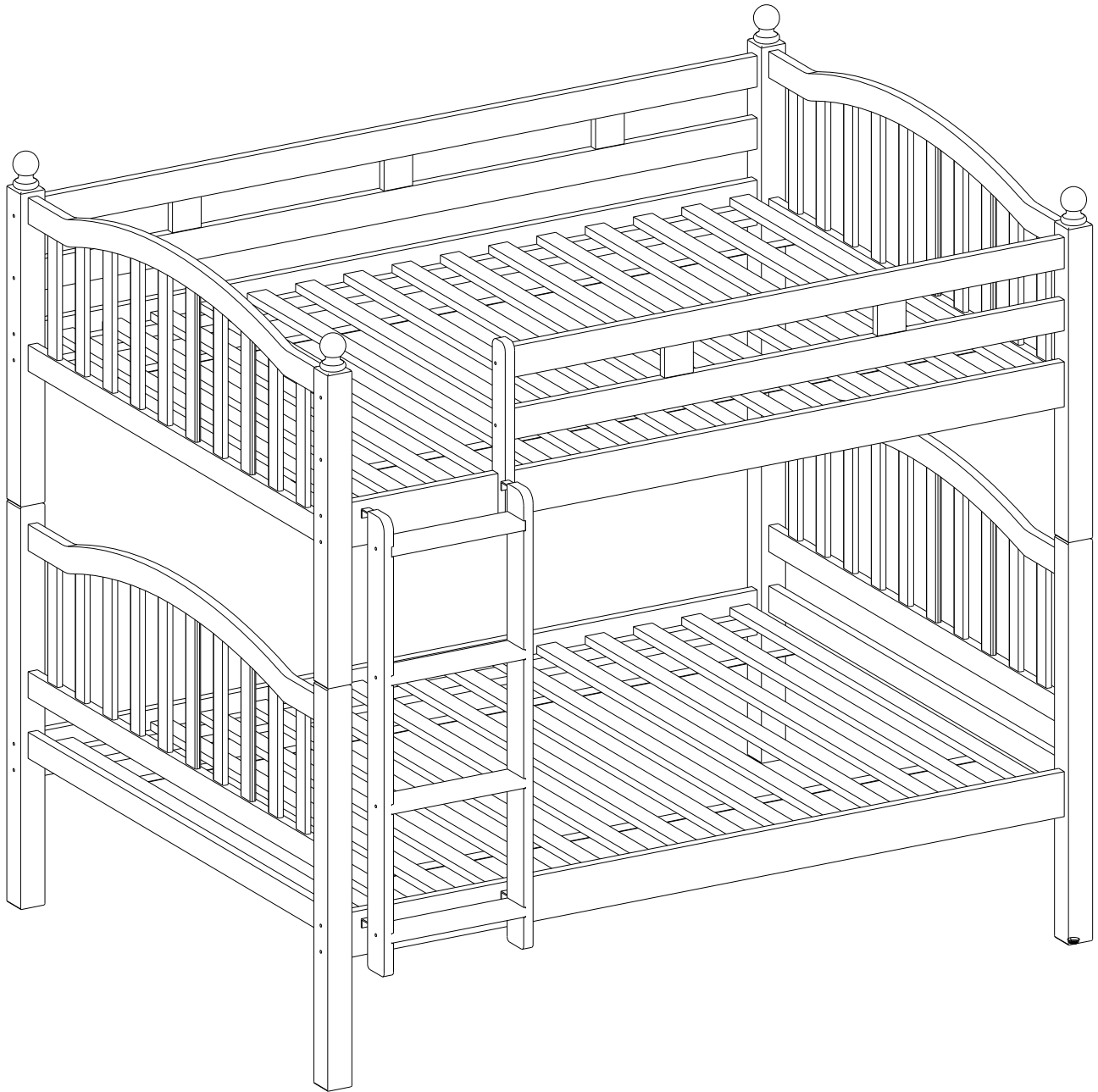

- Use Only standard Twin size mattress (75" long x 54" wide)-
- Maximum mattress thickness must not exceed 8"-
- Surface of mattress must be at least 5" below the upper edge guardrails-
- 200 Lb Upper Bunk Weight Limit

Bunk Bed Assembly Instructions

Please read the instructions and verify that all parts listed on the parts list are complete

Parts List

Part #	Qty	Description	Part #	Qty	Description
A	1	Lower Headboard	J-L	1	Vertical Ladder Support. (left)
B	1	Lower Footboard	J-R	1	Vertical Ladder Support. (right)
C	1	Upper Headboard	J-2	5	Ladder Steps
D	1	Upper Footboard	K	4	Steel Bed Connector Pins
E	3	Mattress Side Rails	L	66	1" Black Wood Screws
EL	1	Ladder Side Rail	Tool	1	Allen Wrench
F	2	Mattress Support Slat Sets	M	2	1 1/2" Guard Rail Post Bolts
G	2	74" Upper Guard Rails (For Back)	N	32	3 3/4" Rail Bolts
H	2	57" Upper Guard Rails (For Front)	O	10	2 1/4" Rails Bolts
I	1	Upper Front Guard Rail Post	P	44	Barrel Nuts
			Q	4	Ladder Hooks

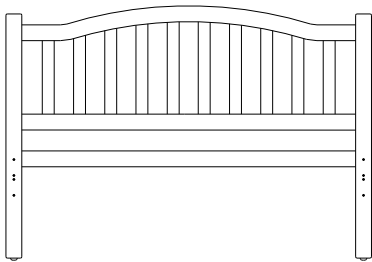

Lower Head Board Part(A)
Lower Head Board Part(B)

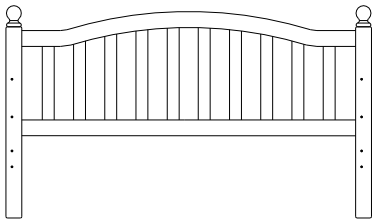

Upper Head Board Part(C)

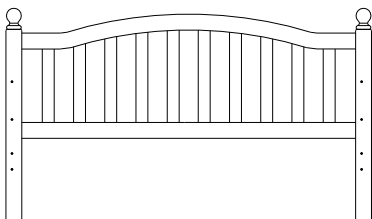

Upper Head Board Part(D)

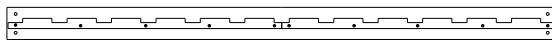

Mattress Side Rail Part(E)

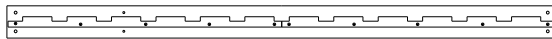

Ladder Side Rail Part(EL)

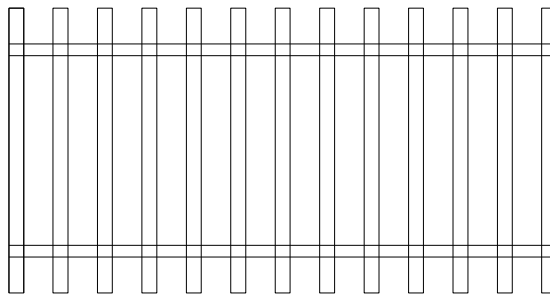

Mattress Support Slats Part(F)

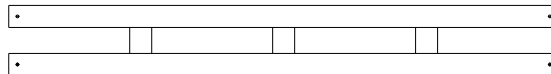

Upper Guard Rail Part(G)

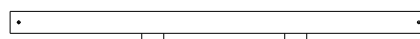

Upper Guard Rail Part (H)
Upper Guard Rail Part(H)



Guard Rail Post Part(I)



Short Bolt 2 1/2 inches (M)



Long Bolt 3 1/4 inches (N)

Ladder Parts
J-L J-R

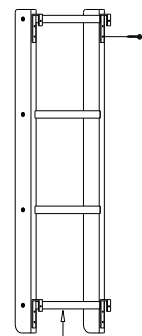

J-2



Plate



Barrel Nut Part(P)



Allen Wrench

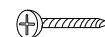

Wood Screw Part (L)



Steel Connector Pin Part(K)

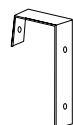

Ladder Hook Part(Q)

Oak Bunk Bed Assembly Instructions.

Step 1 Assembling Lower Bunk

- Insert 2 Barrel Nuts (P) into each end of the Mattress Side Rails (E). Be sure the long slot on the Barrel Nut is facing out and towards the end of the side rail.
- Attach the side rail to the headboard (A) by inserting 2- 3 3/4" Rail Bolts (N) through the holes in the post of the Headboard and into the Barrel Nut in the side rail. Slat slots must face in. **Screw in only part way using the Allen Wrench provided.**
- Repeat this procedure until all 4 corners are attached to both headboard (A) and footboard (B).
- Tighten all bolts

Step 2 Assembling Support Slats

- Layout the Mattress Support Slats (F) with the webbing facing down.
- Insert the slats into the slots in the Mattress Side Rails. Make sure every slot has a slat.
- Screw in each end of the slats using the 1" Wood Screws (L) through the pre drilled holes in the slats.
- Electric screwdriver would be nice about now.

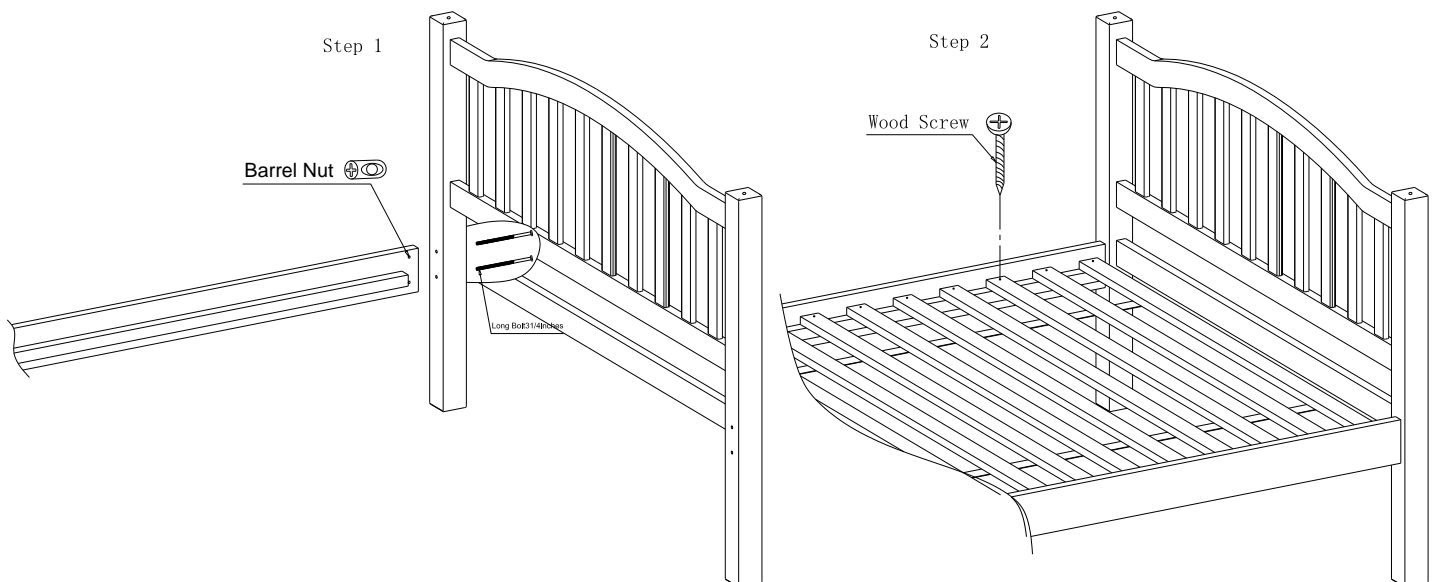

Please follow the Upper Bunk Assembly instructions carefully to insure a safe and sturdy bed.

Step 3 Assembling Upper Bunk

- **DO NOT FULLY TIGHTEN ANY BOLTS UNTIL ALL UPPER BUNK PIECES ARE CONNECTED**
- **The Upper Footboard should be positioned so the Post with the two holes is facing towards the front.**

Back Side – Use the holes that are at the back of the bunk head & footboards to make the following connections

- Attach mattress side rail (E) to upper Headboard (C) into the bottom two holes of the headboard. There are six holes in the headboard; make sure to secure the mattress rail to the bottom two.
- Attach the upper footboard (D) using the Barrel Nuts (P) and Rail Bolts (N). (As in Step 1).
- **WARNING** Label on Headboard must face out away from bed.

Front Side- Use the holes that are at the front of the bunk head & footboards to make the following connections

- Attach Front Ladder Side Rail (EL) to headboard (C) and foot board(D).
- Install Mattress Support Slats (F) as in step 2

Attach Guardrails: (Curved edge of all guard rails must be facing down)

- Attach 2 - 74" Guardrails (G) to the back portion of the upper bunk using the steps described in Step 1. The curved edge must be facing down.
- Mount Guard Rail Post (L) to the front side of Ladder Side Rail (EL) using 2- 1 1/2" bolts (M). No Barrel Nuts are required.
- Attach 2- 57" Guard Rails from the Guard Rail Post (L) to the foot board (D) using 3 3/4" Rail Bolt (N) and Barrel Nuts (P). Curved edge of both Guard Rails must be at the bottom facing down.
- Tighten all bolts.

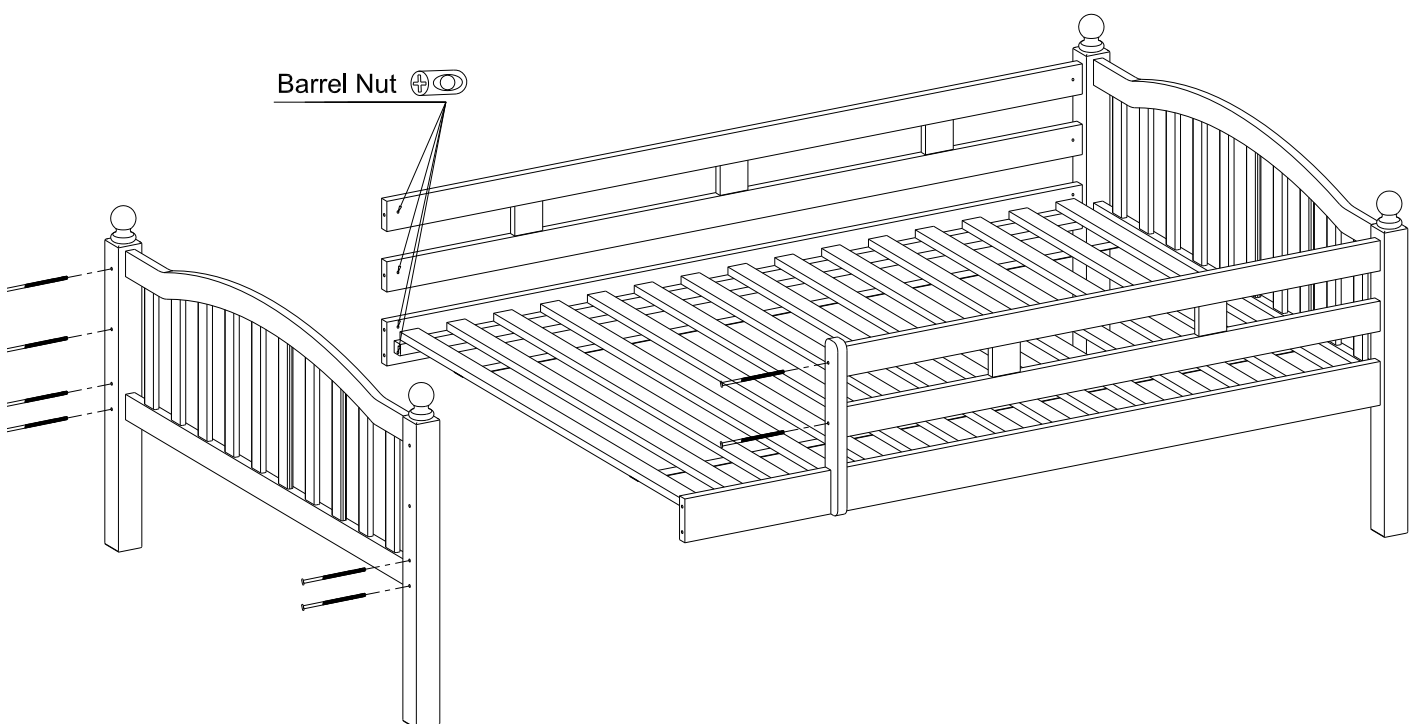

Step 4. Connecting Bunk Beds

- Insert Steel Connector Pins (K) into holes on top of lower bunk posts. Pins should extend 1 1/4" above post.
- Place top bunk over pins and onto Lower bunk.

Step 5. Assembling Ladder

- Attach left ladder support (J-L) to steps (part J-2) using Barrel Nuts (P). The top of the ladder supports have 2 predrilled holes for securing ladder hooks. Make sure to face those holes toward the top before assembling steps. Barrel Nut holes must be on the under side of each step facing down.
- Repeat with right ladder support (J-R).
- Each ladder support has 2 pre drilled holes at the top for the ladder hooks (Q). Attach the Ladder Hooks (Q) using 2 wood screws (L).
- Hook the ladder securely over the top of the Ladder side rail between the guard rail post and the head.
- Secure hook to the ladder side rail using 2 wood screws (L) through the hole in the ladder hook. **Ladder must only be used in this location and secured with 2 screws.**

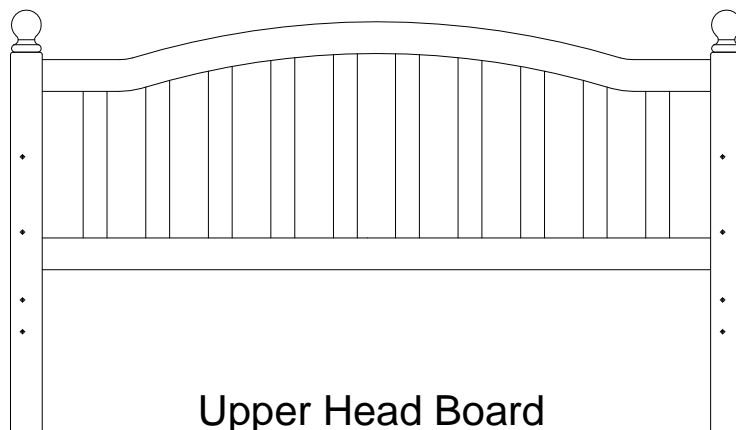

Steel Connector Pin

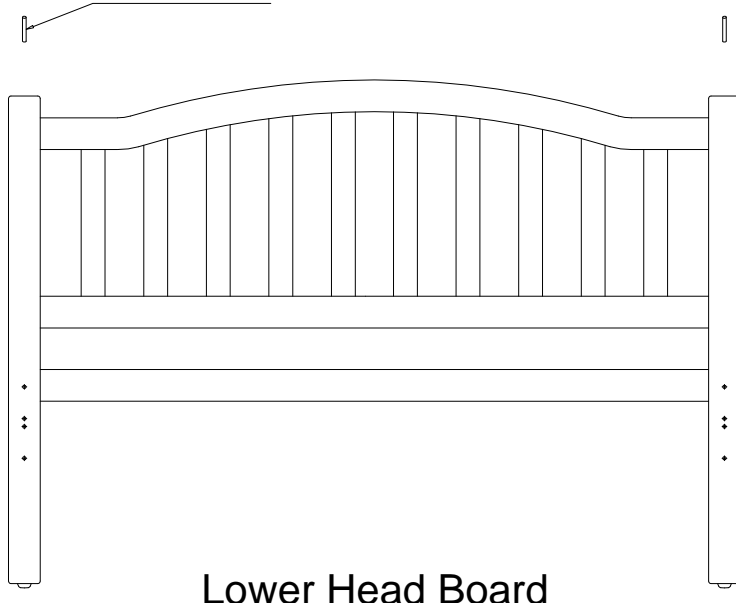

Short Bolt 2 1/2 inches

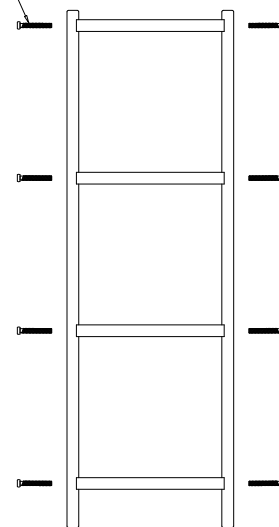

Ladder Parts

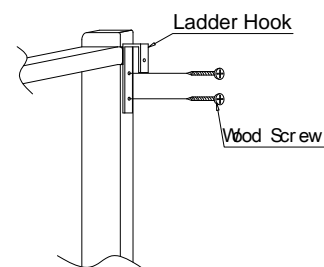

BUNK BED SAFETY WARNINGS

- Follow the Information on the warnings appearing on the Upper bunk end structure and on the carton. Do Not remove warning label from bed.
- Always use the recommended size mattress or mattress support, or both, to help prevent the likelihood of entrapment or falls.
- 200 LB Upper Bunk Weight Limit
- Surface of mattress must be at least 5” (127mm) below the upper edge guardrails.
- Do not allow children less than 6 years of age to use the upper bunk.
- Periodically check and ensure that the guardrail, ladder, and other components are in their proper position, free from damage, and that all connectors are tight.
- Do not allow horseplay on or under the bed and prohibit jumping
- on the bed.
- Always use the ladder for entering and leaving the upper bunk.
- Do not use substitute parts. Contact the manufacturer or dealer for replacement parts.
- Use of a night light may provide added safety precaution for a child using the upper bunk.
- Always use guardrails on both long sides of the upper bunk.
- The use of water or sleep flotation mattress is prohibited.
- Keep these instructions for future reference